

SG-P12-040-010-15-HH-52XX-00000

PLANETARY GEARBOXES

SG 040

$i=010$

$\varphi < 15'$

MADE IN ITALY

IP64

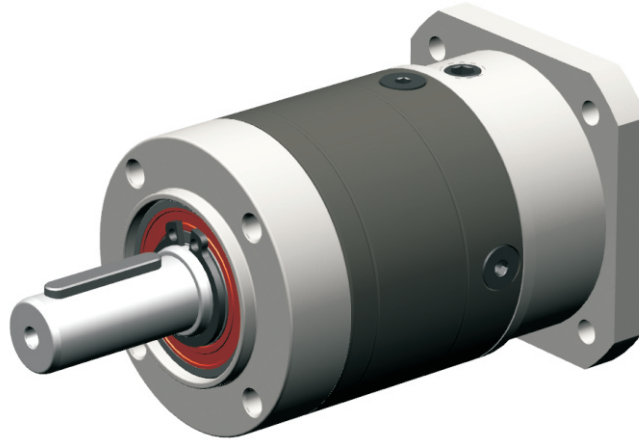

Dimensions (Units:mm)

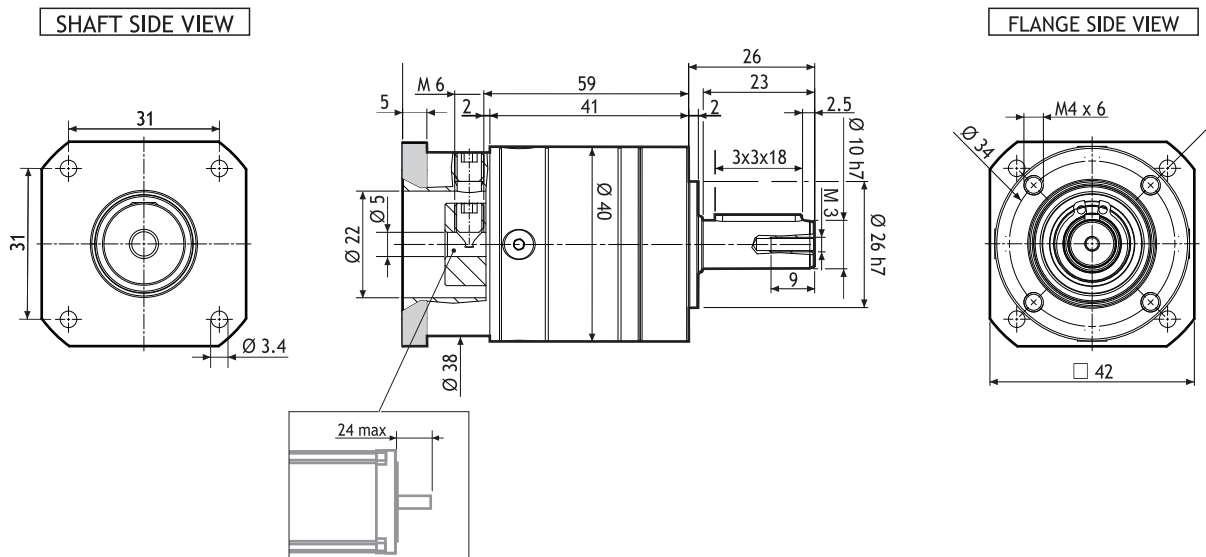

MODEL	Rated output torque [Nm]	Maximum acceleration output torque [Nm]	Emergency step output torque [Nm]	Backlash [arcmin]	Nominal input speed [min ⁻¹]	Maximum momentary input speed [min ⁻¹]	Torsional stiffness [Nm/arcmin]	Maximum radial force applying on output shaft [N]	Maximum axial force applying on output shaft [N]	Gear efficiency [%]	Gear moment of inertia [Kg ^m ²]
SG-P12-040-010-15-HH-52XX-00000	6	9	25	<15'	5000	8000	0.8	220	200	98	1.2x10 ⁻⁶

Suggested motors

	103-H5205 SERIES 	103-H5208 SERIES 	103-H5210 SERIES
MOUNTING OPERATION MODE: ■ Tightening torque M=5 Nm	■ Locking bolt M4		■ R.T.A. Quality Control