

SD SERIES

STEPPING MOTORS

34 frame size

- 8 leads for series or parallel connection
- Ideal for medium motion control systems
- Manufactured for R.T.A. drives
- 2 phase hybrid motors
- 200 step/rev (1.8°/step)
- 86mm (3.4") flange



SPECIFICATIONS

MODEL NUMBER	No. Shafts	No. Stacks	Motor Length (mm)	Phase Current (Amp)	Phase Resistance (Ω)	Phase Inductance (mH)	Holding Torque (Nm)	Rotor Inertia (kg.mm ²)	Voltage Constant (V/krpm)	Motor Mass (kg)
103-807-6341	1	1	61	4.3	0.95	3.8	1.7	56	33	1.4
103-807-6311	2									
103-814-6541	1	2	91	6.5	0.55	2.7	3.5	112	44	2.5
103-814-6511	2									
103-845-6741	1	3	130	9.5	0.45	2.0	5.1	155	46	3.6
103-845-6711	2									

DIMENSIONS (in mm)

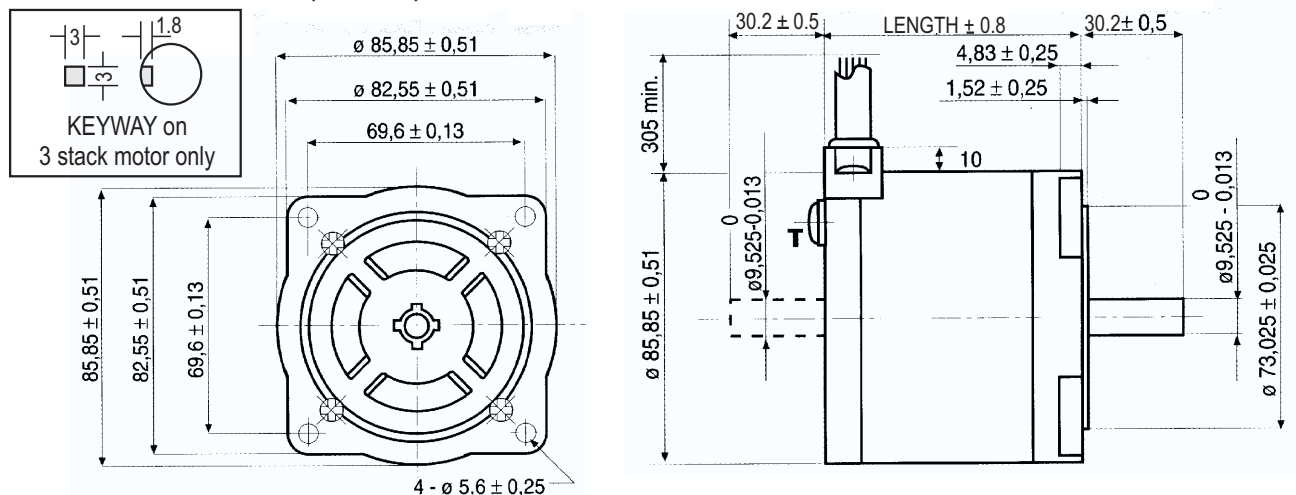

SD34FT

DRIVE CONNECTIONS

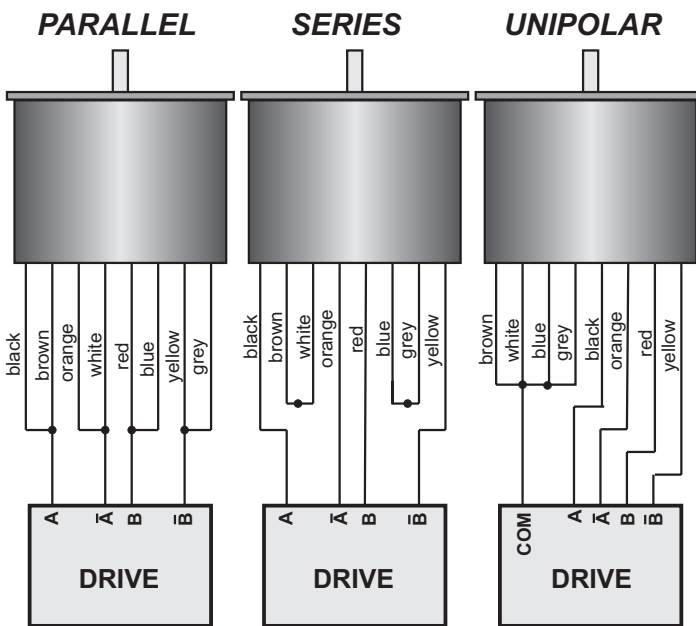

MOTOR CABLES

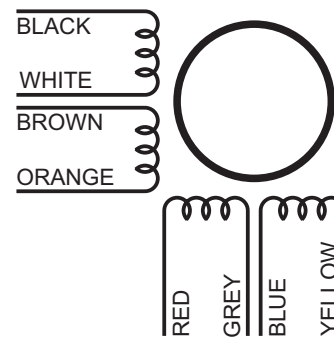

NOTES

MOTOR CURRENT

All motor currents are for parallel connection with a bipolar drive. If connecting in parallel mode, set the drive to no more than this value. If connecting in series mode, set drive current to half this value to prevent overheating the motor.

HOLDING TORQUE

Holding torque is measured for both phases on, motor connected in parallel and drive set to rated motor current.

PROTECTION

Environmental protection IP43

TORQUE CURVES

Drives set to half step mode (400 step/rev).



103-807-6341 & 75V drive (parallel)

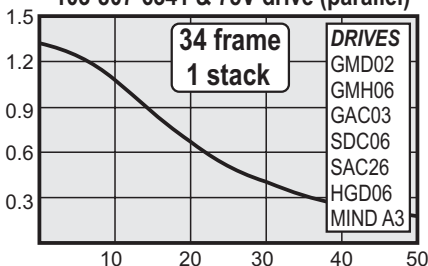

103-807-6341 & 75V drive (series)

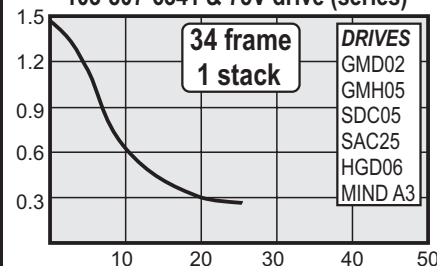

103-814-6541 & 75V drive (series)

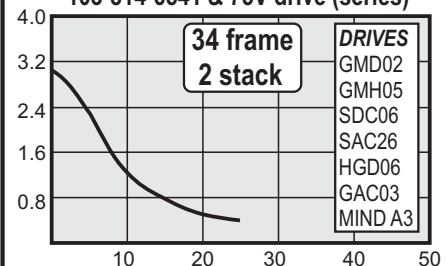

103-814-6541 & 75V drive (parallel)

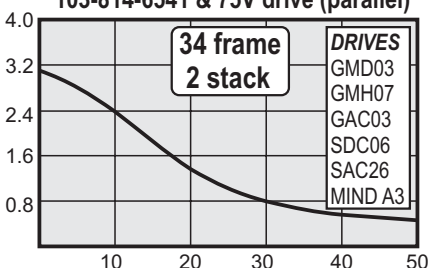

103-814-6541 & 130V drive (parallel)

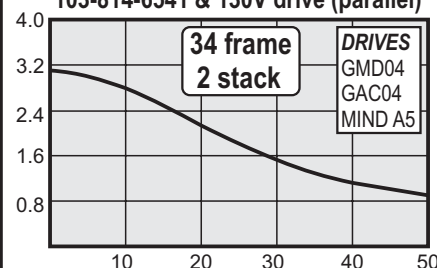

103-845-6741 & 75V drive (series)

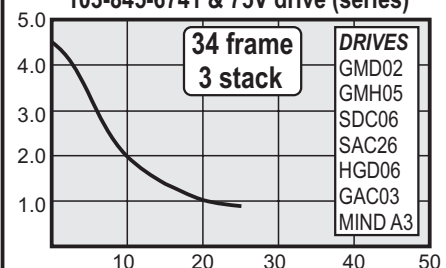

103-845-6741 & 75V drive (parallel)

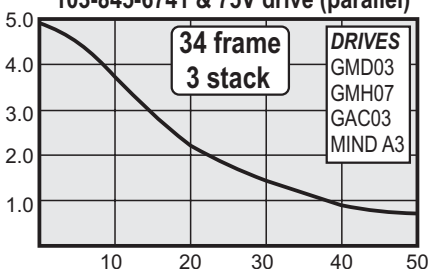

103-845-6741 & 130V drive (parallel)

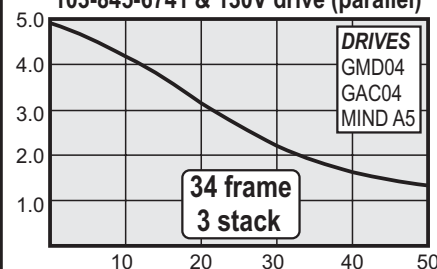

103-845-6741 & 180V drive (parallel)

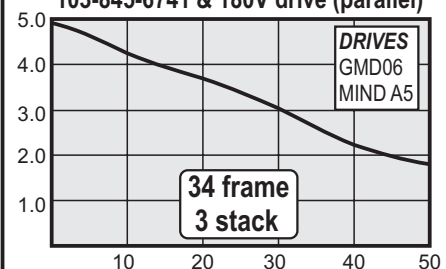

AUTOMATED MOTION SYSTEMS PTY.LTD.

MAILING ADDRESS:
P.O.BOX 1240
WANGARA DC
W.A. 6947

PHONE: (08) 9309 1896
FAX: (08) 9309 5671
EMAIL: sales@automotys.com.au
INTERNET: <http://www.automotys.com.au>

OFFICE ADDRESS:
UNIT2, 7 BARETTA RD.
WANGARA, PERTH
WESTERN AUSTRALIA